



markilux pergola 210 / pergola 210 tracfix

round, square, functional –

protection from the sun and inclement weather for large areas

The markilux 8800 conservatory awning system with slender support posts,
can be lowered on one side – optionally with tracfix system

rated to wind resistance class 3
(corresponds to Beaufort 6)

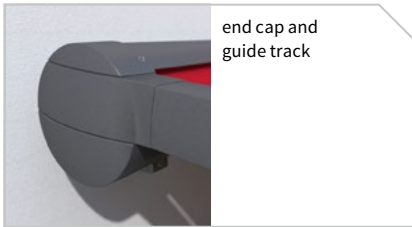

end cap and guide track

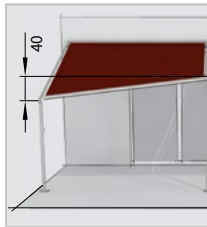

single unit with lowered support post (dimensions in cm)



the post can be lowered by between 20 cm and 40 cm: winch handle operation of the markilux pergola 210



when fully extended the rounded front profile sits flush with the end of the guide tracks, giving the system a completely homogeneous appearance



coupled unit – up to 3 fields are available (only on request)



closed appearance thanks to the tracfix system – the tracfix system does away with the annoying gap between the cover and the guide track



coupled unit with lowered support posts (dimensions in cm)

Design Features

the cassette profile, the guide tracks, the front profile and the front support posts complement one another perfectly and result in a large but nevertheless very elegant patio shading system

large scale awning system resting on slender posts with unobtrusive lateral guide tracks

for long-lasting attractiveness the awning is powder coated in the standard colours traffic white, metallic aluminium, grey brown or anthracite metallic

when fully extended the rounded front profile sits flush with the end of the guide tracks, giving the system a completely homogeneous appearance

Technical Specification

manual height adjustment possible on one side – to ensure water drainage at a minimum installation pitch of 7°; if the pitch is at least 14° water drainage can be guaranteed even if the support post is not lowered

vertical, manual adjustment of the support post by between 20 cm and 40 cm (depends on the awning size) by means of winch handle-operated gearbox inside the post

standard height of the front support posts 250 cm, other heights (from 152 cm to 250 cm) on request

Optional Accessories

coupled units up to 3 fields wide are available in the markilux pergola 210 (only on request)

vertical solar protection and more privacy is optionally available with the 230 cm high shadeplus / drop valance

radio-controlled motor with markilux remote control – ergonomically shaped

polyester powder coating in non-standard colours is available to individual order (prices on request, longer lead time)

wall sealing profile to cover the gap between awning and wall; effective up to an awning pitch of 25°

closed appearance thanks to tracfix system (optional) without the annoying gap between the cover and the guide track

Frame colours

traffic white

RAL 9016

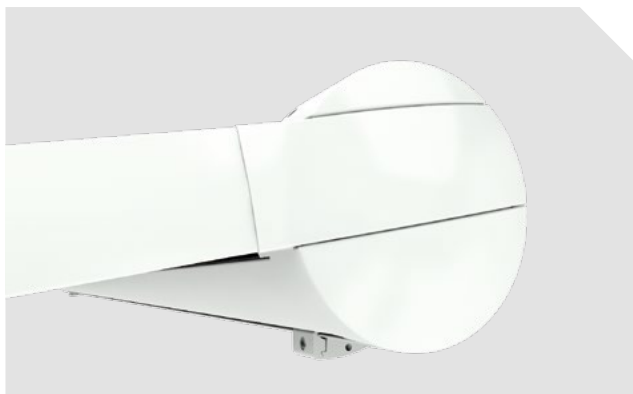

metallic aluminium

RAL 9006

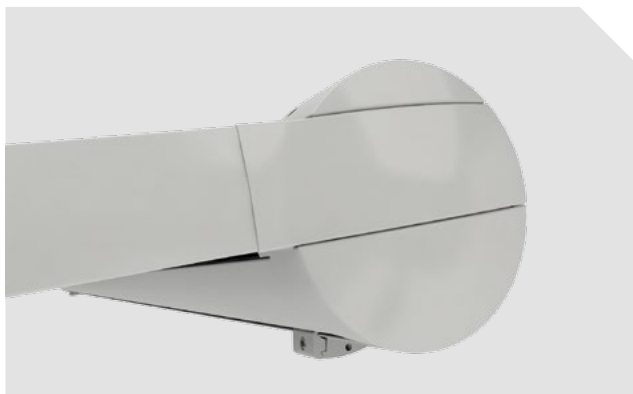

grey brown, similar to

RAL 8019

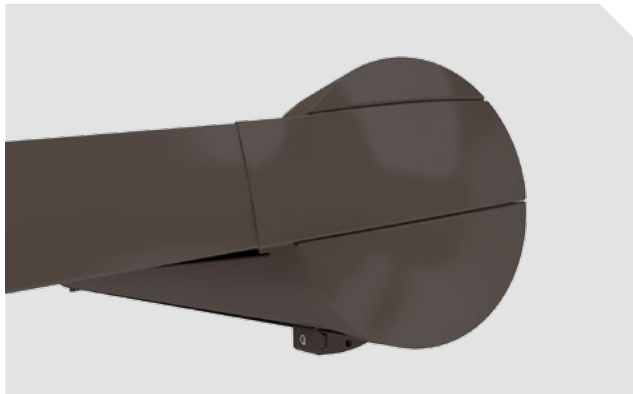

anthracite metallic

5204



01

02

03

04

05

06

07

08

09

10

11

12

13

14

15

16

17

18

19

20

21

22

23

Colours similar to those in the RAL chart. Colours may differ slightly from those depicted in both hue and finish.

Dimensions and configuration options

single unit 1 field, 1 motor

	250	300	350	400	450	500	550	600
	201 250	251 300	301 350	351 400	401 450	451 500	501 550	551 600
M →	+ 10 cm							

	300	—						
	350							
	400							
	450							
	500							—
	550						—	—
	600						—	—

dimensions in cm

HT →	2
-------------	---

= tracfix (optional)

Operation / Drive

	standard	optional
hard-wired motor	<input checked="" type="checkbox"/>	—
radio-controlled motor (433 MHz)	—	<input checked="" type="checkbox"/>
silentec	—	<input checked="" type="checkbox"/> ¹⁾
winch handle operation, front post	<input checked="" type="checkbox"/>	—

1) only 1 field and 2 fields, 2 motors

Dimensions and tolerances

	width	extension
housing tolerances	+ 5 / - 10 mm	
awning cover width = awning fixture width	- 60 mm ²⁾	
awning cover length		on request

2) standard specification; in the case of tracfix on request

Covers

	fabric range no.	standard	optional
sunsilk snc	324 .. / 328 .. / 369 ..	<input checked="" type="checkbox"/>	—
sunsilk perla FR	374 ..	—	<input checked="" type="checkbox"/> ⁴⁾
transolair	338 ..	—	<input checked="" type="checkbox"/>
perfortex	332 ..	<input checked="" type="checkbox"/> ³⁾	—
sunvas snc	310 .. / 311 .. 313 .. — 315 ..	<input checked="" type="checkbox"/>	—
sunvas perla	370 ..	—	<input checked="" type="checkbox"/> ⁴⁾

3) not available in tracfix units

4) only available in tracfix units; from a fixture width of 501 cm, maximum extension 450 cm



Coupled units

	standard	optional
2 fields	—	<input checked="" type="checkbox"/>
3 fields	—	<input checked="" type="checkbox"/> ⁵⁾

5) on request

= tracfix **MA** = awning fixture width **H** = extension
M = overall awning width **HT** = no. of brackets

Frame colours

		standard	optional
traffic white	RAL 9016		
metallic aluminium	RAL 9006		
grey brown, similar to	RAL 8019		
light ivory	RAL 1015		
anthracite metallic	5204		
stone grey metallic	5215		
off-white textured finish	5233		
Havanna brown textured finish	5229		
non-standard powder-coated finish			

Miscellaneous

	standard	optional
shadeplus / drop valance	—	<input checked="" type="checkbox"/> ¹⁾
wall sealing profile	—	<input checked="" type="checkbox"/> ²⁾
tracfix	—	<input checked="" type="checkbox"/>
light and wind sensor	—	<input checked="" type="checkbox"/>

1) **N.B!** Only use the shadeplus / drop valance when the telescopic post has been returned to its raised position! Shadeplus height 230 cm

2) possible up to a maximum awning pitch of 15°

Holes have been punched in the internal gutter area of the front profile at regular intervals to improve the water drainage from the front profile. This may lead to very slight indentations in the front profile at those points; as these are unavoidable, they do not form the basis for complaint.

Colours similar to those in the RAL chart. Colours may differ slightly from those depicted in both hue and finish.

Additional information

The width of the awning cover is always **less** than that of the awning.

Pitch adjustment range: from 5° to 45° (to the horizontal).

Water drainage can only be guaranteed at a **minimum awning pitch of 14°** to the horizontal. If the markilux pergola is to be used as rain protection and the pitch is less than 14°, water drainage can be guaranteed by lowering the telescopic post of the awning. The pitch on installation must, however, be at least 7°.

Definition of fixture width/order width: The fixture width is the measurement centre to centre from guide track to guide track. The overall width of the cassette is 100 mm greater than the fixture width of the awning. The fixture width tolerance is + 0 mm / - 20 mm.

Definition of the extension / order extension: The extension is measured with the awning extended from the back of the cassette to the leading edge of the front profile. The tolerance in the extension is +40 mm / - 40 mm.

Definition of operating side: the operating side is always given as if standing in front of the awning (right or left).

Installation dimensions: The same installation dimensions are valid for both the pergola 210 and the pergola 110 (therefore please consult the page „Installation dimensions“ pergola 110)

N.B! In the case of **continuous motor usage**, the motor may stop after 3 to 4 minutes to prevent overheating.

N.B.! In contrast to standard motors, radio-controlled motors have no safety cut-out mechanism if the front profile is obstructed. If this function is required in combination with radio-controlled operation, order the hard-wired motor with an external radio receiver and an appropriate transmitter.

N.B.! In the case of a bank of awnings operating simultaneously, the same speed of rotation of the motors cannot be guaranteed because of the internal tolerances of the motors.

N.B.! Before extending or retracting the markilux pergola 210, please make sure that the telescopic post has been returned to its raised position!

The rate of extension of a single unit with hard-wired motor is approximately **11 seconds per metre**.

Dimensions and configuration options

Coupled unit, 2 fields, 1 or 2 motors

	600	700	800	900	1000	1100	1200
	551	601	701	801	901	1001	1101
	600	700	800	900	1000	1100	1200
M →	+ 10 cm						

	300						
	350						
	400						
	450						
	500						—
	550						—
	600						—

dimensions in cm

= tracfix (optional)

Fixtures, fittings and accessories

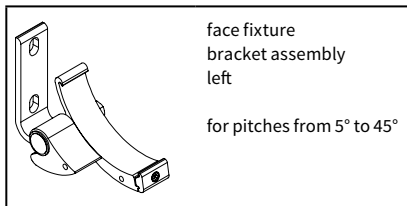

face fixture
bracket assembly
left

for pitches from 5° to 45°

76063.

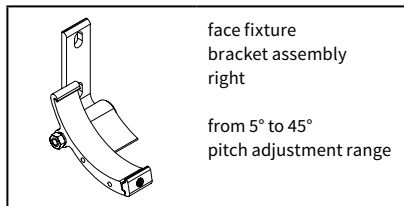

face fixture
bracket assembly
right

from 5° to 45°
pitch adjustment range

76064.

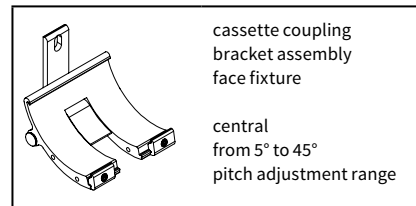

cassette coupling
bracket assembly
face fixture

central
from 5° to 45°
pitch adjustment range

76181.

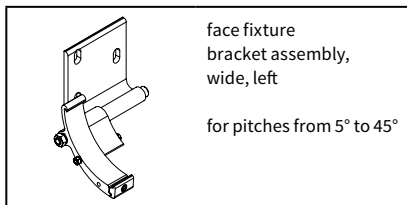

face fixture
bracket assembly,
wide, left

for pitches from 5° to 45°

76231.

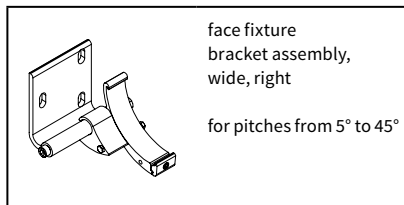

face fixture
bracket assembly,
wide, right

for pitches from 5° to 45°

76232.

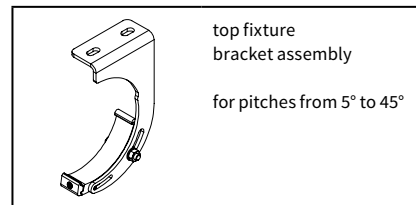

top fixture
bracket assembly

for pitches from 5° to 45°

77058.

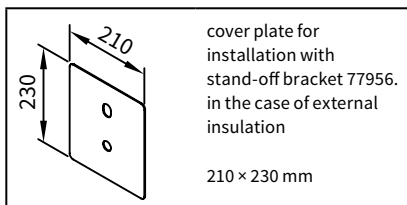

cover plate for
installation with
stand-off bracket 77956.
in the case of external
insulation

210 × 230 mm

71844.

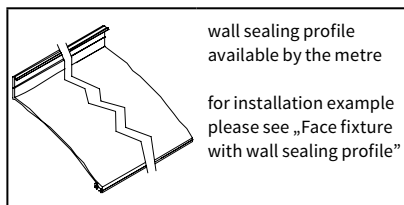

wall sealing profile
available by the metre

for installation example
please see „Face fixture
with wall sealing profile“

77780.

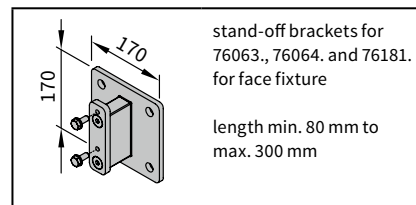

stand-off brackets for
76063., 76064. and 76181.
for face fixture

length min. 80 mm to
max. 300 mm

77956.

dimensions in mm

For installation dimensions please refer to the markilux pergola 110

= tracfix MA = awning fixture width H = extension
M = overall awning width

Front support posts

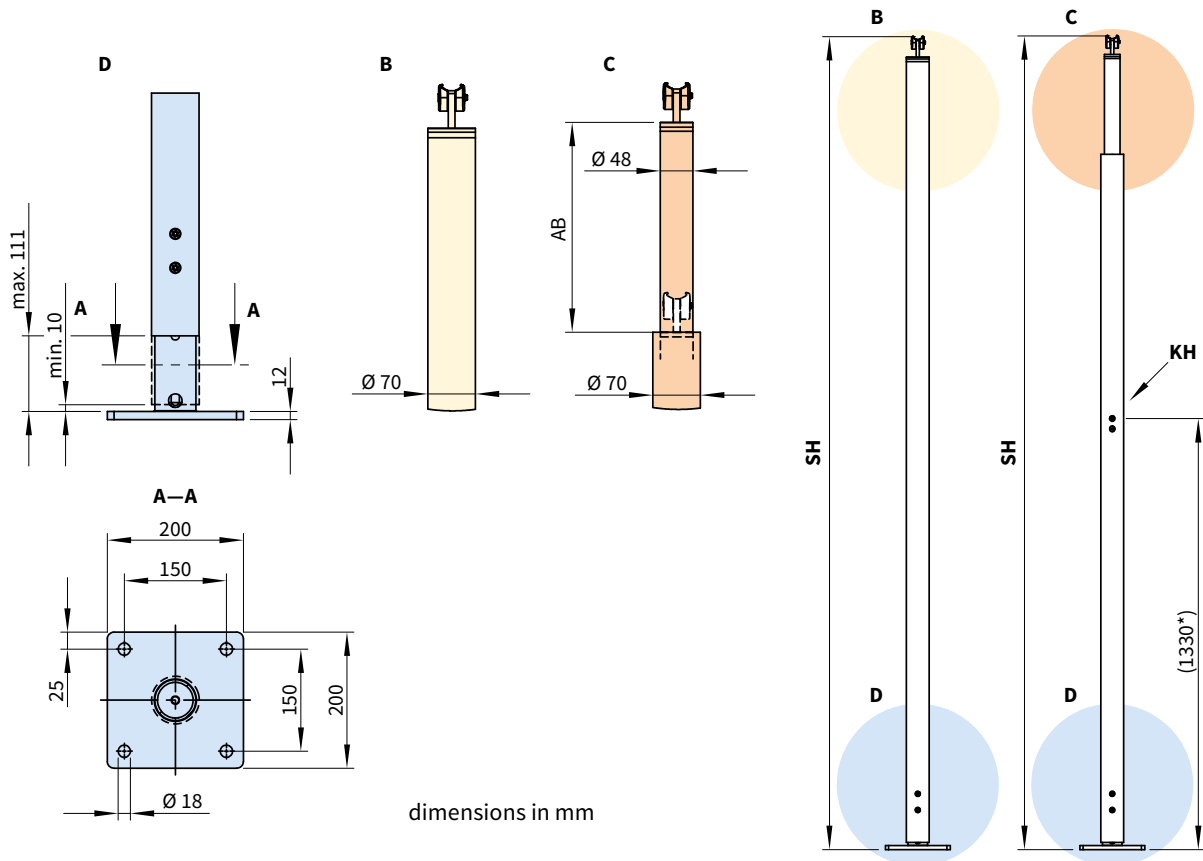

SH = support post height, standard height 2500 mm, special heights (between 1570 mm and 2500 mm) on request

D = height adjustment at the base of both the front support posts during installation approximately 100 mm

B = support post without manual adjustment option

C = support post with manual adjustment option (shown without illustration of the winch handle)

KH = winch handle socket

* = dimensions at the standard height

AB = adjustment range of a post 200 mm, 300 mm or 400 mm (depending on the size of the pergola 210, see matrix below)

Adjustment range (travel) of the telescopic post in relation to the awning size

		201 250	251 300	301 350	351 400	401 450	451 500	501 550	551 600
	201–250	20	20	20	20	30	30	30	30
	251–300	20	20	20	30	30	30	30	30
	301–350	20	30	30	30	30	30	30	30
	351–400	30	30	30	30	30	30	30	30
	401–450	30	30	30	30	30	30	40	40
	451–500	30	30	30	30	30	40	40	—
	501–550	30	30	30	30	40	40	—	—
	551–600	30	30	40	40	40	40	—	—

dimensions in cm

Adjustment range of the support post: = 20 cm = 30 cm = 40 cm

MA = awning fixture width **H** = extension

01
02
03
04
05
06
07
08
09
10
11
12
13
14
15
16
17
18

19
20
21
22
23

Additional Information

Coupled pergolas are available up to a max. width of **2 single units** (2 fields) sided by side. 3 single units adjacent to one another on request.

In the case of coupled units with 2 or 3 fields and 2 motors, **unequal running speeds** due to tolerances within the motors may occur.

In the case of **coupled units** with **fields of differing sizes** smooth rolling-up behaviour of the covers cannot be guaranteed. This has no bearing on the functionality or the durability of either the cover or the pergola itself.

The matrices above assume equal field widths in coupled awnings.

In the case of coupled units up to **a fixture width of 700 cm the cassette** will be supplied **in one piece**. If, for reasons of transportation or fixture, the cassette needs to be split, please note this explicitly when ordering.

The rate of extension of coupled units with **2 fields, 1 Motor and 3 fields, 2 motors** is approximately **16 to 18 seconds per metre**. In the case of coupled units with **2 fields, 2 motors** extension takes as long as with single awnings i.e. approximately **12 to 14 seconds per metre**.

In the case of **2 motors**, the individual motors can be operated independently of one another.

Maximum awning size: please refer to the table for single units! Please also refer to the matrix for single units for the dimensions possible with the **tracfix system**.

If coupled pergolas are fitted into a **recess** or **reveal** the overall width of the coupled awning must be at least 6 cm less than the width of the opening to allow the pergola to be coupled.